

TASCAM[®]
TEAC PROFESSIONAL

DR-07

Portable Digital Recorder

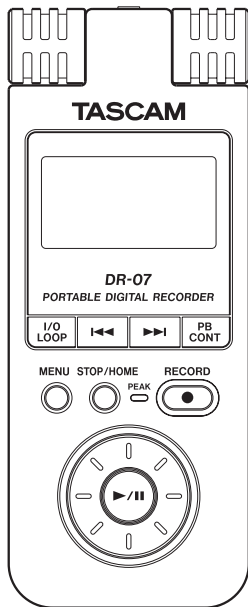

This device has a serial number located on the bottom panel. Please record it and retain it for your records.
Serial number:

OWNER'S MANUAL

IMPORTANT SAFETY INSTRUCTIONS

- 1 Read these instructions.
- 2 Keep these instructions.
- 3 Heed all warnings.
- 4 Follow all instructions.
- 5 Do not use this apparatus near water.
- 6 Clean only with dry cloth.
- 7 Do not block any ventilation openings. Install in accordance with the manufacturer's instructions.
- 8 Do not install near any heat sources such as radiators, heat registers, stoves, or other apparatus (including amplifiers) that produce heat.
- 9 Do not defeat the safety purpose of the polarized or grounding-type plug. A polarized plug has two blades with one wider than the other. A grounding type plug has two blades and a third grounding prong. The wide blade or the third prong are provided for your safety. If the provided plug does not fit into your outlet, consult an electrician for replacement of the obsolete outlet.
- 10 Protect the power cord from being walked on or pinched particularly at plugs, convenience receptacles, and the point where they exit from the apparatus.
- 11 Only use attachments/accessories specified by the manufacturer.
- 12 Use only with the cart, stand, tripod, bracket, or table specified by the manufacturer, or sold with the apparatus. When a cart is used, use caution when moving the cart/apparatus combination to avoid injury from tip-over.



- 13 Unplug this apparatus during lightning storms or when unused for long periods of time.
- 14 Refer all servicing to qualified service personnel. Servicing is required when the apparatus has been damaged in any way, such as power-supply cord or plug is damaged, liquid has been spilled or objects have fallen into the apparatus, the apparatus has been exposed to rain or moisture, does not operate normally, or has been dropped.
 - Do not expose this apparatus to drips or splashes.
 - Do not place any objects filled with liquids, such as vases, on the apparatus.
 - Do not install this apparatus in a confined space such as a book case or similar unit.
 - The apparatus draws nominal non-operating power from the AC outlet with its POWER or STANDBY/ON switch not in the ON position.
 - The apparatus should be located close enough to the AC outlet so that you can easily grasp the power cord plug at any time.
 - The main plug is used as the disconnect device, the disconnect device shall remain readily operable.
 - An apparatus with Class I construction shall be connected to an AC outlet with a protective grounding connection.
 - Batteries (battery pack or batteries installed) should not be exposed to excessive heat such as sunshine, fire or the like.

IMPORTANT SAFETY INSTRUCTIONS

- Excessive sound pressure from earphones and headphones can cause hearing loss.

Warnings and Cautions about Batteries

This product uses batteries. Misuse of batteries could cause a leak, rupture or other trouble. Always abide by the following precautions when using batteries.

- Never recharge non-rechargeable batteries. The batteries could rupture or leak, causing fire or injury.
- When installing batteries, pay attention to the polarity indications (plus/minus (+/-) orientation), and install them correctly in the battery compartment as indicated. Putting them in backward could make the batteries rupture or leak, causing fire, injury or stains around them.
- When throwing used batteries away, follow the disposal instructions indicated on the batteries and the local disposal laws.
- Do not use batteries other than those specified. Do not mix and use new and old batteries or different types of batteries together. The batteries could rupture or leak, causing fire, injury or stains around them.
- Do not carry or store batteries together with small metal objects. The batteries could short, causing leak, rupture or other trouble.
- Do not heat or disassemble batteries. Do not put them in fire or water. Batteries could rupture or leak, causing fire, injury or stains around them.
- If the battery fluid leaks, wipe away any fluid on the battery case before inserting new batteries. If the battery fluid gets in an eye, it could cause loss of eyesight. If fluid does enter

an eye, wash it out thoroughly with clean water without rubbing the eye and then consult a doctor immediately. If the fluid gets on a person's body or clothing, it could cause skin injuries or burns. If this should happen, wash it off with clean water and then consult a doctor immediately.

- The unit power should be off when you install and replace batteries.
- Remove the batteries if you do not plan to use the unit for a long time. Batteries could rupture or leak, causing fire, injury or stains around them. If the battery fluid leaks, wipe away any fluid on the battery compartment before inserting new batteries.

Declaration of Conformity

Model Number : DR-07
Trade Name : TASCAM
Responsible party : TEAC AMERICA, INC.
Address : 7733 Telegraph Road, Montebello,
California, U.S. A.
Telephone number : 1-323-726-0303

This device complies with Part 15 of the FCC Rules. Operation is subject to the following two conditions: (1) this device may not cause harmful interference, and (2) this device must accept any interference received, including interference that may cause undesired operation.

IMPORTANT SAFETY INSTRUCTIONS

FOR U.S.A.

TO THE USER

This equipment has been tested and found to comply with the limits for a Class B digital device, pursuant to Part 15 of the FCC Rules. These limits are designed to provide reasonable protection against harmful interference in a residential installation. This equipment generates, uses, and can radiate radio frequency energy and, if not installed and used in accordance with the instruction manual, may cause harmful interference to radio communications. However, there is no guarantee that interference will not occur in a particular installation. If this equipment does cause harmful interference to radio or television reception, which can be determined by turning the equipment off and on, the user is encouraged to try to correct the interference by one or more of the following measures.

- a) Reorient or relocate the receiving antenna.
- b) Increase the separation between the equipment and receiver.
- c) Connect the equipment into an outlet on a circuit different from that to which the receiver is connected.
- d) Consult the dealer or an experienced radio/TV technician for help.

CAUTION

Changes or modifications to this equipment not expressly approved by TEAC CORPORATION for compliance could void the user's authority to operate this equipment.

Information for Users on Collection and Disposal of Old Equipment and used Batteries

These symbols on the products, packaging, and/or accompanying documents mean that used electrical and electronic products and batteries should not be mixed with general household waste. For proper treatment, recovery and recycling of old products and used batteries, please take them to applicable collection points, in accordance with your national legislation and the Directives 2002/96/EC and 2006/66/EC.

By disposing of these products and batteries correctly, you will help to save valuable resources and prevent any potential negative effects on human health and the environment which could otherwise arise from inappropriate waste handling.

For more information about collection and recycling of old products and batteries, please contact your local municipality, your waste disposal service or the point of sale where you purchased the items.

Information on Disposal in other Countries outside the European Union

These symbols are only valid in the European Union. If you wish to discard these items, please contact your local authorities or dealer and ask for the correct method of disposal.

IMPORTANT SAFETY INSTRUCTIONS

Note for the battery symbol (bottom right two symbol examples)

This symbol might be used in combination with a chemical symbol. In this case it complies with the requirement set by the Directive for the chemical involved.



产品有毒有害物质或元素的名称及含量

机种：DR-07		有毒有害物质或元素					
	品名	铅 (Pb)	汞 (Hg)	镉 (Cd)	六价铬 (Cr(VI))	多溴联苯 (PBB)	多溴二苯醚 (PBDE)
1	CHASSIS 部份	○	○	○	○	○	○
2	PCB Assy 部份	×	○	○	○	○	○
3	附属品部份	×	○	○	○	○	○
4	SEAL 部份	○	○	○	○	○	○
5	包装部份	○	○	○	○	○	○

- ：表示该有毒有害物质在该部件所有均质材料中的含有量均在 SJ/T11363-2006 标准规定的限量要求以下。
×：表示该有毒有害物质至少在该部件的某一均质材料中的含量超出 SJ/T11363-2006 标准规定的限量要求。
(针对现在代替技术困难的电子部品及合金中的铅)

Table of Contents

1—Introduction	9	Left side panel	26
Main functions	9	Rear Panel	27
About this manual	9	Bottom panel.	27
Supplied accessories	11	4—Screen Overview	29
Trademarks.	11	Home Screen	29
About SD cards	12	Record Screen	32
Precautions for use	13	Setting Screens	34
Cleaning the unit	13	Setting screen structure	34
2—Preparation.	14	Operation basics	36
Inserting the SD card	14	Operation example	37
Removing the SD card	15	5—Making Connections.	39
Inserting a new card	15	Connecting mics and other audio devices	39
Other cases that require formatting	15	Connecting to the MIC IN jack	39
Write-protected cards	16	Connecting to the LINE IN jack.	40
Powering the unit.	17	Connecting monitors	40
Installing the batteries	17	Connecting with a computer.	41
Using an AC adapter (purchased separately)	18	Disconnecting from a computer	42
Turning the power on and off	18	6—Copying Tracks from a Computer.	43
Setting the date and time	19	Preparing audio files on a computer	43
Windscreen	21	Copying audio files from a computer	43
3—Part Names and Functions	22	Managing the Music Folder from a computer	44
Top panel	22	7—Playback.	45
Right side panel	25		

Table of Contents

Starting and stopping playback	45	Editing the playlist	64
Selecting tracks.	45	10–Browse Screen	67
Search forward and backward	46	Screen navigation.	67
Using the wheel to change the playback position	46	Icons on the BROWSE screen	68
Adjusting the volume	47	File operations	68
8–Recording	48	Folder operations	69
Selecting the file type and sampling frequency	48	11–Special Playback Control Functions	71
Selecting the input source	49	Setting the playback control functions	71
Setting the MIC input functions	50	Changing the speed.	72
Display of input functions on the Record Screen.	52	Change speed without changing pitch	72
Adjusting the input recording levels	52	Changing the pitch without changing the speed	73
Recording	54	12–Loop, Repeat and Single Playback	74
Special functions during recording	55	Loop playback	74
Track incrementing	55	Repeat and single track playback modes	75
Pre-recording	57	13–System Settings and Formatting	76
Recording delay	57	Making System Settings	76
File divide function	58	Restoring the factory settings	77
9–Playback Area and Playlist	60	Formatting the SD card	77
Setting the playback area	60	Using QUICK FORMAT	78
Selecting a folder for the playback area	61	Using FULL FORMAT	78
Selecting a file to set the playback area	62	14–Viewing File Information	79
Playlist	63	File information page	79
Adding tracks to the playlist	63		

Table of Contents

Card information page	80
System information page	81
15–LCD Menu List	82
16–Messages	85
17–Specifications.	91
Dimensions.	94

1-Introduction

Thank you very much for purchasing the TASCAM DR-07 Portable Recorder. Please read this Owner's Manual carefully in order to maximize your use of all the unit's features. We hope that you will enjoy using this recorder for many years to come. Please make copies of this manual and keep them in safe places for future reference.

Main functions

Portable recorder

- Use SD cards as the recording media
- Record with the built-in microphone, or by connecting a microphone or the line output of a CD player, instrument or other audio device
- Choose MP3 (32 kbps–320 kbps, 44.1 kHz or 48 kHz) or WAV (16-bit or 24-bit, 44.1 kHz or 48 kHz) audio file types for recording

Other features

- Special playback functions include deaccelerating playback speed without changing pitch

and changing pitch without changing playback speed.

- Copy audio files from a computer to this unit's SD card by USB connection

About this manual

This manual is provided both as a printed document and as an electronic file stored on the included SD card.

To access the Owner's Manual on the included SD card, install the SD card in the unit if it has not been installed already, and use the included USB cable to connect the unit to a computer (see "Connecting with a computer" on page 41 for how to make the connection).

The Owner's Manual file is in the Manual folder inside the DR-07 folder. In order to open the file, Adobe Reader (or other software that can open pdf files) must be installed on your computer.

1-Introduction

Adobe Reader can be downloaded for free from the Internet.

CAUTION

- *We recommend that you make a backup copy of the Owner's Manual file on your computer hard disk, a CD-R or other media.*
- *If you accidentally erase the Owner's Manual file, you can download it again from our web site (<http://www.tascam.com>).*

Font use conventions

- Controls, keys and other parts on the DR-07 are written like this: **MENU**.
- Messages shown on the display are written like this: `Are you sure?`
- We use the term “key” to describe the push-button controls on the DR-07.

Tracks and files are the same

Tracks are files, and files are tracks.

In this manual, we usually use the word “track” when we are describing the playback of a song, for example, just as we would if talking about songs on a CD or a portable music player. However, when we talk about their data properties, such as sampling frequencies and ID3 tags, we often refer to the same “tracks” as “files” because they can be manipulated in ways similar to files on a computer.

TIP We give hints and tips on using the DR-07 when you see this icon.

NOTE A note provides additional explanations for special situations.

CAUTION A caution shows that you may lose data (recordings) if you do not follow the instructions.

1-Introduction

Supplied accessories

- SD card (in the unit) 1
- USB cable 1
- AA battery 2
- Windscreen 1
- Owner's Manual or Quick Start Guide 1
- Warranty card 1

Please contact the store where you purchased this unit if any of these accessories are missing or have been damaged during transportation.

Trademarks

SD Logo is a trademark.



SDHC Logo is a trademark.



Microsoft, Windows, Windows XP, and Windows Vista are either registered trademarks or trademarks of Microsoft Corporation in the United States and/or other countries.

Macintosh, Mac OS and Mac OS X are trademarks of Apple Inc., registered in the U.S. and other countries.

Other company names, product names and logos in this document are the trademarks or registered trademarks of their respective owners.

This product is designed to help you record and reproduce sound works to which you own the copyright, or where you have obtained permission from the copyright holder or the rightful licensor. Unless you own the copyright, or have obtained the appropriate permission from the copyright holder or the rightful licensor, your unauthorized recording, reproduction or distribution thereof may result in severe criminal penalties under copyright laws and international copyright treaties. If you are uncertain

1-Introduction

about your rights, contact your legal advisor. Under no circumstances will TEAC Corporation be responsible for the consequences of any illegal copying performed using the DR-07.

MPEG Layer-3 audio coding technology licensed from Fraunhofer IIS and Thomson.

Supply of this product does not convey a license nor imply any right to distribute MPEG Layer-3 compliant content created with this product in revenue-generating broadcast systems (terrestrial, satellite, cable and/or other distribution channels), streaming applications (via Internet, intranets and/or other networks), other content distribution systems (pay-audio or audio-on-demand applications and the like) or on physical media (compact discs, digital versatile discs, semiconductor chips, hard drives, memory cards and the like). An independent license for such use is required. For details, please visit <http://mp3licensing.com>.

About SD cards

Since this unit uses an SD card for recording and playback, you must insert an SD card into the unit before use. You can use 64 MB–2 GB SD cards and 4 GB–32 GB SDHC cards with this unit.

Please see the TASCAM web site (www.tascam.com) for information about cards that have been tested with the DR-07.

NOTE

When new, this unit comes with an SD card inserted. This card can be used for recording and playback as is. There is no need to reinsert or format it.

Precautions for use

SD cards are delicate media. In order to avoid damaging a card or the card slot, please take the following precautions when handling them.

- Do not leave them in extremely hot or cold places.
- Do not leave them in extremely humid places.
- Do not let them get wet.
- Do not put things on top of them or twist them.
- Do not hit them.

Cleaning the unit

To clean the unit, wipe gently with a soft dry cloth. Do not use any benzene, paint thinner, ethyl alcohol or other chemical agents to clean the unit as they could damage the surface.

2-Preparation

Inserting the SD card

An SD card is used as recording media for recording and playback.

- Cards that comply with SD and SDHC standards can be used.
- A list of SD cards that have been tested with this unit can be found on the TASCAM web site (www.tascam.com).

The SD card slot and the USB connector are under the cover on the left side of the unit. The SD card is to be inserted in here.

If you try to force the SD card in the wrong way, the slot and the card could be damaged, so please use caution.

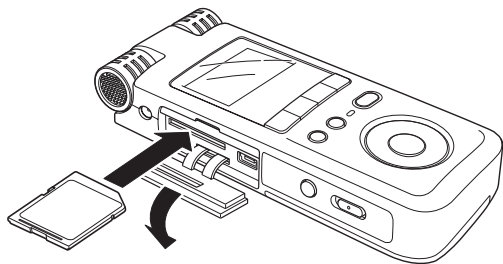

NOTE

An SD card is pre-installed when the unit is new. There is no need to reset this SD card before using it to record or play files.

- 1. Press the cover down in the direction of the arrow to open it.**
- 2. Insert the SD card in the SD card slot and push it until it clicks fully into place.**
- 3. Close the cover after inserting the card.**

2-Preparation

Removing the SD card

1. Make sure the unit power is off.
2. Press the inserted SD card in gently and it will disengage from the unit so that you can pull it out completely.

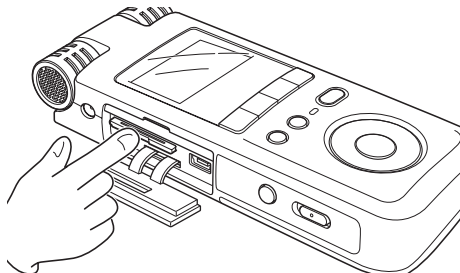

CAUTION

Do not remove the SD card during recording or playback, or when the unit is connected to the computer by USB. Be sure to turn off the unit's power before removing the card.

Inserting a new card

The following pop-up screen appears if you insert a new card in the unit.

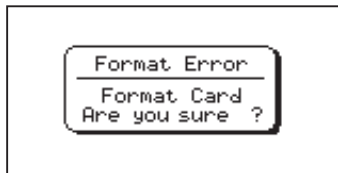

Press the ►/|| key to format the card so that it can be used with this unit.

When formatting finishes, the Home Screen appears.

Other cases that require formatting

- The above "FORMAT ERROR" screen also appears if you install an SD card that was formatted by a device other than the DR-07. Reformat the card to use it with this unit.

2-Preparation

CAUTION

Formatting an SD card erases all files that are on it. Make certain that you have copied any files that you want to save from the card before formatting it.

- The following pop-up screen appears if a system file or other crucial file was accidentally erased from the SD card when used with a computer

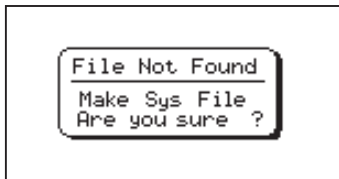

In either case, press ▶/|| to reformat the card.

TIP

Always make backup copies of important files as soon as you can.

Write-protected cards

SD cards have write-protect (lock) switches.

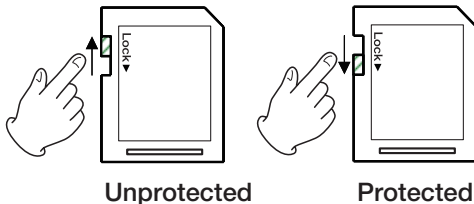

Files cannot be recorded or edited on a card if you slide its switch down.

Slide the switch down if you want to prevent the contents of the card from being changed or erased.

If a protected SD card is inserted, playback is possible, but you will not be able to record or edit files.

2-Preparation

Powering the unit

The DR-07 can be operated using two AA batteries or an optional AC adapter (PS-P520). This unit can use alkaline or Ni-MH batteries.

NOTE

When using batteries to power the unit, use the BATTERY TYPE item on the SETUP screen to set the type of batteries you are using (see "Select the type of batteries" on page 77).

Installing the batteries

Slide the battery compartment cover on the back of the unit to open it, and insert the two AA batteries (supplied) observing the battery polarity (+ and -) marked in the battery compartment.

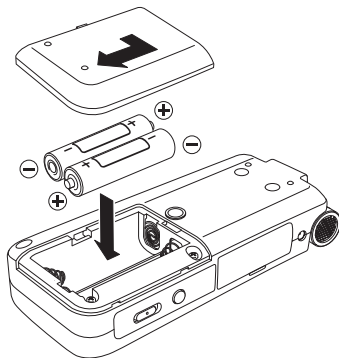

NOTE

The included alkaline batteries are for confirming operation of the unit and might not last very long.

2-Preparation

Using an AC adapter (purchased separately)

To use the PS-P520 AC adapter (sold separately), connect the adapter to the unit and the adapter to the power cord before plugging it into an outlet.

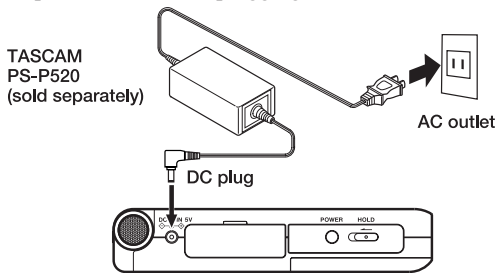

NOTE

When both batteries are installed and the AC adapter is connected, power will be supplied from the AC adapter.

CAUTION

Use only the PS-P520 AC adapter. Using an AC adapter other than the specified can cause a malfunction, fire, or electric shock.

Turning the power on and off

To turn the power ON, press and hold the **POWER** key on the left side panel until “TASCAM DR-07” appears on the display.

The Home Screen appears when the unit starts up.



Start-up screen

2-Preparation



Home Screen

To turn off:

To turn the power OFF, press and hold the **POWER** key until “PORTABLE DIGITAL RECORDER” appears on the display.



The power turns off after the unit completes its shut down process.

CAUTION

Do not remove the batteries or disconnect the power cable accidentally while the unit is operating. If you do so, the unit cannot shut down properly and all unsaved data will be lost. Lost data cannot be restored. We recommend that you also save the data manually often.

Setting the date and time

Follow these procedures to set the date and time of the built-in clock. When you create an audio file, date and time information is included in the file data.

- 1 Press the **MENU** key to open the Menu Screen.
- 2 Use the wheel to select **DATE/TIME** and press the **▶/||** key to open the

2-Preparation

Date/Time Screen.

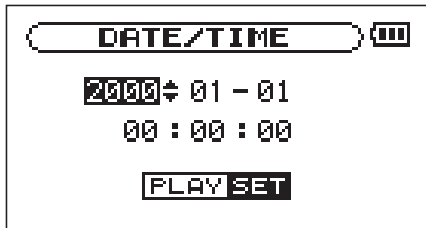

The clock stops while this screen is displayed.

- 3 Use the ◀◀ and ▶▶ keys to move the cursor (the part highlighted in inverse) and use the wheel to set the values.
- 4 After making the setting, press the ▶/|| key to restart the clock from the newly set value.

The display returns to the Menu Screen.

NOTE

- The contents of date and time settings last only several minutes if the power is not supplied by batteries or an AC adapter. We recommend that you replace the batteries before they deplete completely when you power the unit only by the batteries.
- We also recommend that you install batteries even you are using an AC adapter. The setting can be retained by this even the AC adapter is disconnected.
- If the setting is reset, make the setting again.

2-Preparation

Windscreen

By covering this unit's built-in stereo mics with a windscreen, noise caused by wind and other sources can be reduced.

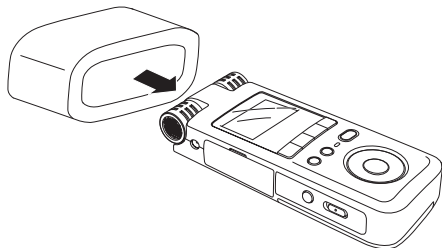

3-Part Names and Functions

Top panel

① Built-in stereo microphone

To use this stereo electret condenser microphone as the input source, select “MIC” on the Input Setting screen. If you connect an external microphone to the **MIC IN** jack on the rear panel, the built-in microphone becomes inactive.

② Display

In addition to the Home Screen, this shows the recording screen, various setting screens, and other operation information. (See “Screen Overview” on page 29.)

③ I/O LOOP key

Use this key to set the IN (start) and OUT (end) points, and playback the interval (loop playback). Also, use this key to cancel the loop playback. (See “Loop playback” on page 73.)

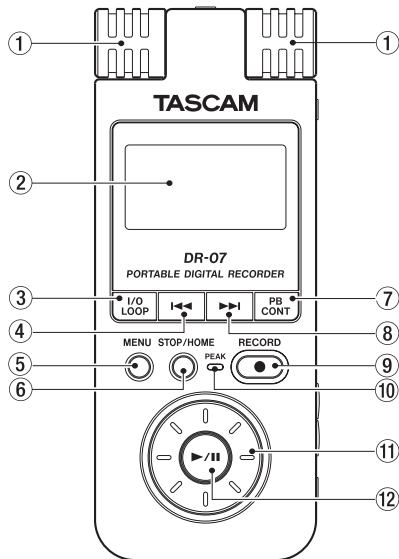

3-Part Names and Functions

④ **⏮ key**

Press this key to return to the beginning of a track that is playing or stopped in the middle.

If you press this key when a track is stopped at its beginning, the unit will skip to the beginning of the previous track.

Press and hold this key to search backwards.

On the setting screens, use this key to move the cursor left. On the Browse Screen, press this key to move up a level.

⑤ **MENU key**

When the Home Screen is displayed, press this key to open the Menu Screen.

Press this key to return to the Menu Screen from the various setting screens.

When the Menu Screen is displayed, press this key to return to the Home Screen.

⑥ **STOP/HOME key**

Press this key to stop recording and playback or to end recording standby.

When a setting screen is open, press to return to the Home Screen.

On a setting screen, use this key to respond “NO” to a confirmation message.

⑦ **PB CONT key**

Press and hold this key to open the Playback Control (PB CONTROL) Screen. When the Playback Control Screen is open, press and hold this key to return to the Home Screen. (See “Special playback control functions” on page 71.)

Briefly press this key to turn the speed control that is set on the Playback Control Screen (VSA and/or SPEED) ON and OFF. When ON, the **SPEED ▲** icon appears at the top of the Home Screen as light letters on a dark background.

⑧ **▶▶ key**

Press this key during playback or when playback is stopped to skip to beginning of the next track.

Press and hold this key to search forward.

3-Part Names and Functions

On the setting screens, use this key to move the cursor right.

On the Browse Screen, press this key to move down a level.

NOTE

Keys ⑥ and ⑦ may not work for all VBR (Variable Bit Rate) MP3 files. For some VBR MP3 files, operating these keys may cause the sound to be not synchronized with the elapsed time shown on the display and the end parts of the file being played back may be repeated at the end of the track. In this case, stop playback to return to normal operation.

⑨ RECORD key

When playback is stopped, press this key to put the unit into recording standby. When in standby, this key flashes.

When in recording standby, press this key to start recording. The key lights while recording.

When recording, press this key to pause recording.

⑩ PEAK indicator

This lights when the selected input signal exceeds the maximum level.

⑪ Wheel

When a setting screen is open, use the Wheel to change the setting of the selected item.

When the Home Screen is open, use the wheel to adjust the file playback position.

⑫ ►/|| key

When the Home Screen is displayed and playback is stopped, press this key to start playback. During playback, press this key to stop playback at the current position.

When using a setting screen, use this key, for example, to confirm a selection, advance a level in a menu and answer “YES” to a confirmation message

3-Part Names and Functions

Right side panel

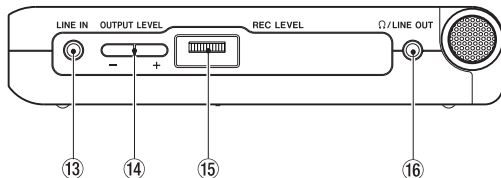

⑩ Ω/LINE OUT jack

Use this to connect with headphones or the line input jack of an amp or other equipment. During recording or recording standby, this outputs the input signals and in other cases, this outputs the playback signal.

⑬ LINE IN jack

Use this stereo mini-jack for line input.

⑭ OUTPUT LEVEL (+, -) keys

Use these keys to adjust the signal level output from the Ω/LINE OUT jack. The volume level appears on the display during adjustment.

⑮ REC LEVEL volume

Use this to adjust the input signal level of the built-in microphone, the MIC IN jack and the LINE IN jack.

3-Part Names and Functions

Left side panel

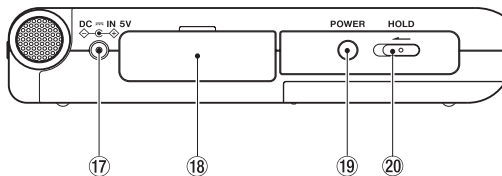

①⑦ **DC  IN 5V jack**

Connect a TASCAM PS-P520 AC adapter (purchased separately) to this jack. Do not connect other adapters.

①⑧ **SD card slot lid**

①⑨ **POWER key**

Press and hold this key to turn the unit's power ON and OFF.

②⑦ **HOLD switch**

Slide this to the left to turn the hold function ON. All keys are inoperative when hold is ON.

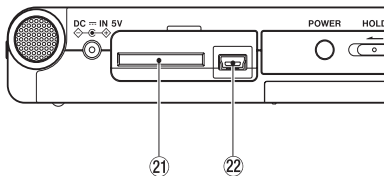

[When the card slot cover opened]

②① **SD card slot**

Insert an SD card into this slot. (See “About SD cards” on page 12.)

②② **USB port**

Use the included USB cable to connect with a computer USB port. (See “Connecting with a computer” on page 41.)

CAUTION

Please connect the unit directly to a computer without using a USB hub.

3-Part Names and Functions

Rear Panel

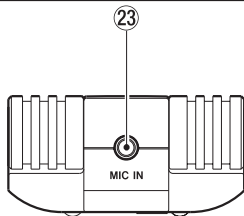

23 MIC IN jack

Use this input jack to connect a stereo mini-jack microphone. This jack provides plug-in power when set to do so on the Input Setting Screen.

NOTE

- We call this the Rear Panel because this is the end that faces away from the operator of the unit when placed on a table with the built-in mic (this end) facing the sound source.
- Connecting a mic to the MIC IN connector disables the built-in mics.

Bottom panel

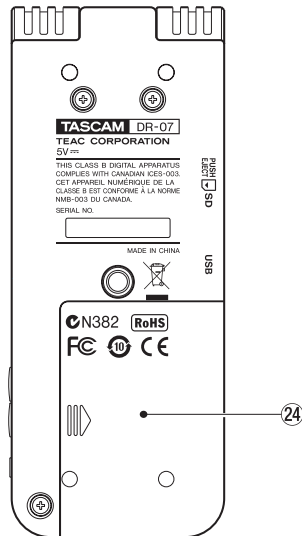

24 Battery compartment cover

3-Part Names and Functions

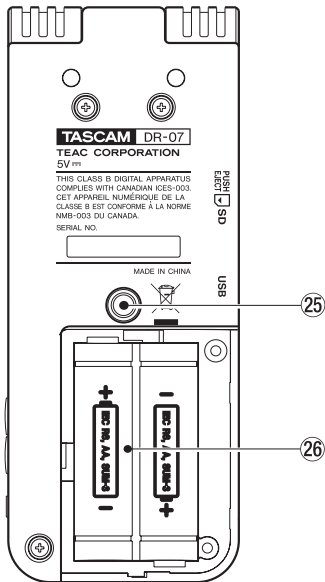

25 Tripod screw socket (1/4 inch)

This unit can be attached to a tripod or a mic stand.

CAUTION

- *Always tighten all the screws on the tripod or the mic stand to avoid the risk of the unit falling and being damaged.*
- *When using this unit while attached to a tripod or a mic stand, place the tripod or mic stand on a flat surface.*

26 Battery compartment

This holds two AA batteries.

[When the battery compartment cover removed]

4-Screen Overview

The display of the unit shows various screens.

- When the unit is ordinarily playing or stopped, the Home Screen appears on the display.
- The Record Screen appears when the unit is recording or in recording standby.
- Setting screens appear when making various settings.

The following sections provide an overview of the appearance and operation of the Home Screen and the record screen, as well as an overview of the screens for various settings.

Home Screen

The items that appear on the Home Screen are explained below. See the explanations later in this chapter for the setting screens and the Record Screen.

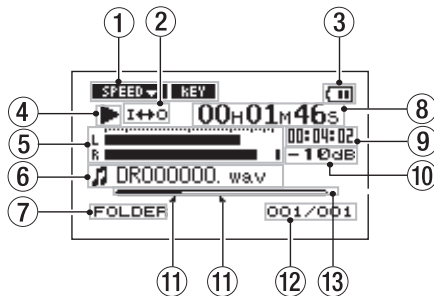

① Status of playback control function settings





These show whether the various playback control functions (speed control and key change) are currently active. When they are active, their icons appear as light letters on a

4-Screen Overview



dark background (, ). (See “Special Playback Control Functions” on page 71.)

② Loop/repeat setting status

The following icons appear depending on the current loop/repeat setting.

	Single playback
	Repeat playback of 1 track
	Repeat playback of all tracks in the play area
	Loop repeat active

③ Power status display







When batteries are being used a battery icon appears. The icon blinks when it is necessary to change the batteries. The icon shows the approximate amount of remaining battery power (, , ) with more bars indicating more power.

When the battery power is almost gone, the  icon blinks, warning that the power is about to turn OFF.

When using the AC adapter (sold separately)  appears.

④ Unit status

The following icons appear to show the current operation status.

-  Track playing
-  File stopped in progress (paused)
-  File stopped at its beginning
-  Fast forwarding
-  Fast rewinding
-  Skipping to the beginning of the next track
-  Skipping to the beginning of the current or previous track

⑤ Level meter

This shows the level of the selected input signal during recording and recording pause, and the level of the playback signal in other cases.

If the input level exceeds the maximum

4-Screen Overview

allowable level, a dot is lit at the right end of the level meter.

⑥ File information

The tag information or file name of the currently playing track is shown. If an MP3 file has ID3 tag information, the ID3 tag information is given priority. The file name is shown for WAV files and for MP3 files that do not have ID3 tag information.

NOTE

ID3 tag information includes the title, artist name and other information that can be saved in an MP3 file.

⑦ Selected playback area

Shows the currently selected playback area.

ALL	All files in the Music Folder
FOLDER	All files in the selected sub-folder of the Music Folder
P.LIST	Files added to the playlist

⑧ Elapsed time

Shows the elapsed time (hours: minutes: seconds) of the currently playing track.

⑨ Remaining time

Shows the remaining playback time of the current track (hours: minutes: seconds).

⑩ dB display

Shows the value of the maximum level in dB during each time interval.

⑪ Status of loop IN and OUT points

This shows the status of the IN and OUT point settings for loop playback.

If an IN point is set, the  icon appears under the display bar at the position equivalent to the playback location.

If an OUT point is set, the  icon appears under the display bar at the position equivalent to the playback location.

⑫ Playback file number/total number of files

The total number of files in the selected playback area and the number of the current file are shown.

4-Screen Overview

⑬ Playback position display bar

This bar shows the current playback position. The bar darkens from the left as playback proceeds.

Record Screen

This screen opens when you press the **RECORD** key to start recording standby mode and stays open when you press the **RECORD** key again to start recording.

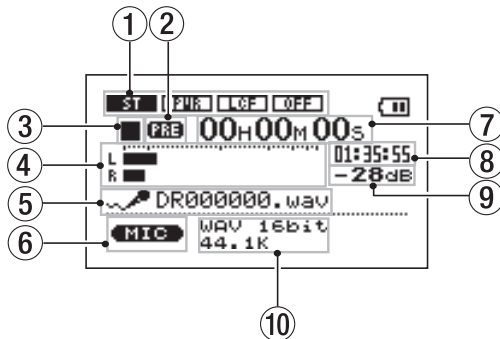

This status of the power and the effect use appears the same as on the Home Screen. This screen also shows the following.

4-Screen Overview

① MIC input setting status

Shows the status of settings related to the built-in microphone and MIC IN jack on the rear panel (stereo recording, plug-in power, low cut filter and level control).

② Pre-recording setting status

PRE appears when pre-recording is set.

③ Recorder operation



Recording



Recording paused



Recording stopped

④ Record level meter

The input signal level of the selected input appears as separate L and R channels.

⑤ File name

Shows the file name that is automatically assigned to the file being recorded.

⑥ Input selection

Shows the input source.

⑦ Elapsed recording time

The elapsed recording time of the track appears as hours: minutes: seconds.

During recording standby, the maximum remaining recording time appears.

⑧ Remaining recording time

The remaining recording time appears in hours: minutes: seconds.

⑨ dB display

Shows the value of the maximum level in dB during each time interval.

⑩ Record mode

Shows the recording file type and sampling frequency.

4–Screen Overview

Setting Screens

Use this unit's various setting screens to make various settings, conduct operations and show information.

NOTE

Although the various setting screens are also used to execute functions and display information, for example, in addition to making settings, we call them "setting screens" in this manual.

Setting screen structure

Most of the setting screens are accessed by first pressing the **MENU** button to open the Menu Screen, but some screens can also be accessed directly using dedicated keys.

The following table provides an overview of the setting screens.

4-Screen Overview

Screen	Overview	Access method
INFORMATION	View file information, system setting information, and system information	Press the MENU key to open the Menu Screen and select the desired setting screen
BROWSE	View music files and sub-folders in the Music Folder, play and erase files, add files to the playlist, create and select folders	
PLAYLIST	Edit the playlist (erase and move tracks in it)	
PLAY MODE	Set playback mode Set single or repeat mode	
INPUT SETTING	Select input source, make built-in microphone and MIC IN settings	
REC SETTING	Make settings related to recording (file type, sampling frequency, maximum file size) Turn pre-recording and recording delay functions ON and OFF	
DIVIDE	Divide files	
SETUP	Make various system settings Initialize and format the SD card	
DATE/TIME	Set the date and time of the built-in clock	
PLAYBACK CONTROL	Set playback control function settings	

4-Screen Overview

Operation basics

Use the **MENU**, **STOP/HOME**, **▶/||**, **◀◀** and **▶▶** keys and the **wheel** to conduct most operations on the various setting screens.

The keys have the following functions.

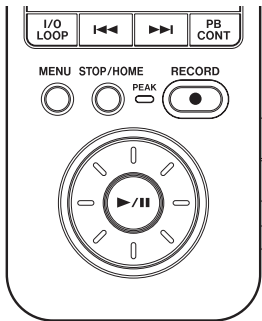

MENU key

Press this key to open the Menu Screen (except when the Menu Screen is already open or the Record screen is open).

When the Menu Screen is open, press this key to return to the Home Screen. When the Record Screen is open, press this key to open the menu of the Input Setting screen.

You can also make settings for items other than **INPUT** on the Input Setting screen.

Wheel

Use the wheel to change the value of the selected item.

▶/|| key

Press this key to make an item selection and to answer “YES” to a confirmation message. (This functions like the “ENTER” key on a computer).

◀◀ key

When a setting screen is open, moves the cursor (part highlighted in inverse) to the left within the screen. Use this after setting the value of an item to return to item selection, for example.

4-Screen Overview

▶▶ key

When a setting screen is open, moves the cursor (part highlighted in inverse) to the right within the screen. In many cases, the ▶/|| key can also be used this way.

STOP/HOME key:

When a setting screen is open, press to return to the Home Screen. Press this key to answer “NO” to a confirmation message.

TIP

You can also use menus during playback

Operation example

In this example, we will use the CUE/REV SPEED item in the Setup Screen to change the forward/reverse search speed.

- 1 When the Home Screen is displayed, press the MENU key to open the Menu Screen.

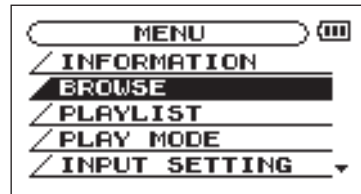

- 2 Turn the wheel to select SETUP (highlighted in inverse), and press the ▶/|| key to open the Setup Screen.
- 3 Turn the wheel to select the CUE/REV SPEED item, and press the ▶/|| key to

4-Screen Overview

show the current setting value (the factory setting is “X8”) highlighted in inverse.

- 4 Turn the wheel to select the desired setting. The setting is changed immediately, so there is no need to press the ►/|| key again to confirm it.
- 5 Press STOP/HOME to return to the Home Screen.

NOTE

- When the ▼ icon appears in the lower right part of the screen, as shown in the preceding image, there is additional information for the current screen below what is shown on the display.
- When the ▲ icon appears, there is additional information for the current screen above what is shown on the display.
- You can also use the ►► key instead of the ►/|| key in these steps.
- When the ▲ icon appears to the right of a setting value, you can change that value by turning the wheel to the right. When the ▼ icon appears to the right of a setting value, you can change that value by turning the wheel to the left.

5–Making Connections

Connecting mics and other audio devices

This unit has a built-in stereo microphone that you can use to practice or record your singing, for example, but you can also use an external mic or other device as an input. You can connect external sound sources to the line input jack or the microphone input jacks. The following sections explain how to use the jacks to connect external devices. (See “Selecting the input source” on page 49 for more about making settings related to connections and input level setting.)

Connecting to the MIC IN jack

You can connect a one-point stereo electret condenser microphone, for example, to the **MIC IN** jack (stereo mini-jack) on the rear panel. Use the Input Setting Screen to adjust the level control, the low cut filter and other settings. (See “Selecting the input source” on page 49.)

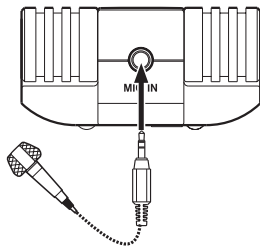

5-Making Connections

Connecting to the LINE IN jack

You can connect the line output of an audio device, for example, to the **LINE IN** jack (stereo mini-jack) on the right side panel.

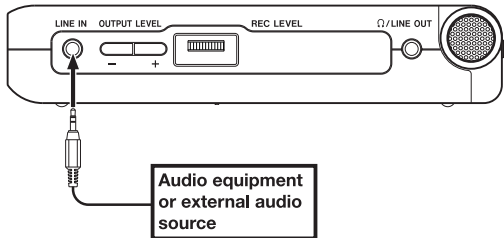

Connecting monitors

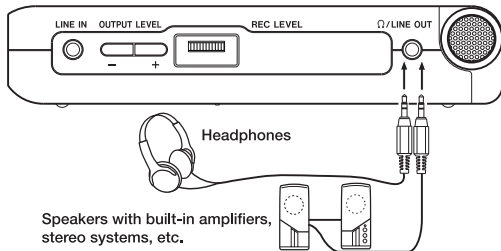

Connect headphones, speakers with built-in amplifiers, an amp and speaker system or other monitoring system to the DR-07 **LINE OUT** jack.

NOTE

*The auto gain function and stereo/mono switching cannot be applied to a signal input through the **LINE IN**.*

5-Making Connections

Connecting with a computer

By connecting this unit with a computer, you can copy WAV or MP3 music files from the computer to this unit. From the computer you can also erase files on this unit and manipulate folders.

To connect to a computer, open the lid on the left side of the unit, use the included USB cable to connect the USB port of the DR-07 and the computer.

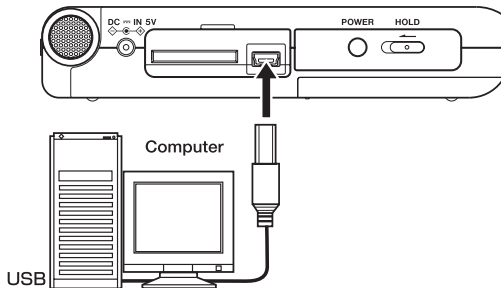

CAUTION

The unit cannot be used when connected with a computer by USB.

When connected, “USB connected” appears on the DR-07 screen.

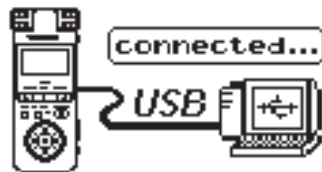

The recorder appears on the computer screen as an external drive named “DR-07.”

NOTE

When shipped from the factory the “DR-07” drive contains the “MUSIC” and “UTILITY” folders, as well as the “MANUAL” folder, which contains a PDF copy of this Owner’s Manual.

5-Making Connections

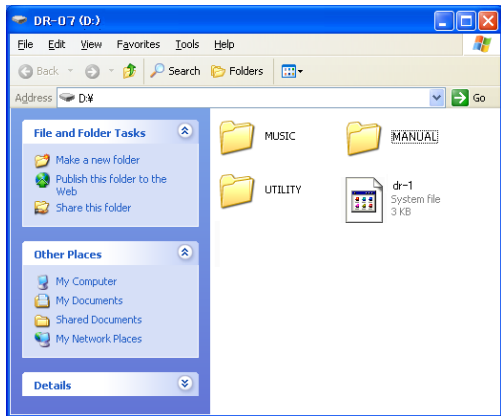

Disconnecting from a computer

To end the USB connection, first follow the procedures for your computer to disconnect the DR-07 and then remove the USB cable. The DR-07 automatically restarts.

See the computer manual for how to close the connection on the computer.

6–Copying Tracks from a Computer

You can transfer audio files from a computer by USB to this unit for playback.

This unit can handle MP3 (32–320 kbps, 44.1/48 kHz) and WAV (44.1/48 kHz, 16/24-bit) audio file types.

Preparing audio files on a computer

Use the abilities of your computer OS or a software application to copy tracks from a CD or other source to your computer.

When copying files to you computer, choose file types that the DR-07 can handle (the types of MP3s and WAV files listed above).

TIP

You can also prepare your own tracks using digital audio software, or use tracks you previously recorded with the DR-07 or another device.

Copying audio files from a computer

- 1 **Connect the DR-07 to a computer (See “Connecting with a computer” on page 35).**
- 2 **Click the DR-07 drive on your computer to see its contents, including the UTILITY, MUSIC and MANUAL folders.**
- 3 **Drag-and-drop audio files from your computer to the Music Folder to copy them to the SD Card in the DR-07.**
- 4 **After you finish copying files and ending the connection with the DR-07 on the computer, disconnect the USB cable (or remove the SD card if it is connected directly to the computer).**

See the computer manual for how to close the connection on the computer.

The DR-07 automatically restarts after it has been disconnected.

6–Copying Tracks from a Computer

NOTE

Instead of using USB to connect the DR-07 and a computer, you can also conduct the same operations by removing the SD card from the DR-07 and connecting it directly to a computer that has a built-in SD card slot or by using a card reader.

TIP

*You can use more than one SD card with the DR-07. Make certain that you format additional cards by inserting them in the DR-07 and following the instructions about formatting (see *Formatting the SD card on page 75.*) before you copy files from your computer.*

Since all storage media, including SD cards, can fail, it is a good idea to make back-up copies of your recordings on your computer hard drive, CD-Rs or other media.

Managing the Music Folder from a computer

You can manage the contents of the Music Folder on an SD Card in the DR-07 from a computer.

You can create up to two levels of sub-folders inside the Music Folder. The DR-07 does not recognize folders and audio files at or below the third sub-level.

Since you can set the DR-07 to only play the contents of a specific folder, you can organize tracks into genres, artists or other categories as you like. (See “Folder operations” on page 62.)

- If you name the sub-folders and music tracks, these names will appear on the screen of this unit.

When the Home Screen is displayed, use the ►/II, ◀◀ and ▶▶ keys to operate the DR-07 as you would with an ordinary CD player or other audio device.

Use the wheel to change the playback position.

NOTE

- *When the Home Screen is not displayed, these keys and the wheel have different functions.*
- *SD Cards formatted by a TASCAM DR-1 or GT-R1 can also be used.*

Starting and stopping playback

Play a track

When playback is stopped, press the ►/II key to start playback.

Stop playback

During playback, press the STOP/HOME or ►/II key to stop (or pause) it at the current position.

Selecting tracks

Use the ◀◀ and ▶▶ keys to select tracks both during playing and when playback is stopped.

During playback or when a track is stopped in the middle, press the ◀◀ key to return to the beginning of the current track.

When stopped at the beginning of a track, press the ◀◀ key to skip to the beginning of the previous track, or press the ▶▶ key to skip to the beginning of the next track.

NOTE

- *Only files in the playback area that is currently set can be selected for playback. (See "Setting the playback area" on page 54.)*

7-Playback

- The track name, file number and other file information for the currently playing track appear on the display.
- The ■ icon appears on the display when playback is stopped at the beginning of a track, and the ■■ icon appears when playback is stopped in the middle of a track (paused).

Search forward and backward

Press and hold the ◀◀ key to search backwards or the ▶▶ key to search forwards.

NOTE

Use the CUE/REV SPEED item on the Setup Screen to change the search speed. (See “Making system settings” on page 74.)

Using the wheel to change the playback position

You can use the wheel to adjust the playback position within a track. When you turn the wheel, the position in the playback position display bar changes, so you can visually confirm that the playback position has been moved.

Moreover, the faster the wheel is turned the more the position is changed.

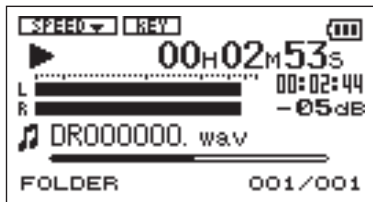

NOTE

No sound is output while you turn the wheel.

Adjusting the volume

Use the **OUTPUT LEVEL (+, -)** keys to adjust the volume of the monitoring signal output from the **Ω/LINE OUT** jack. The volume level appears on the display while being adjusted.

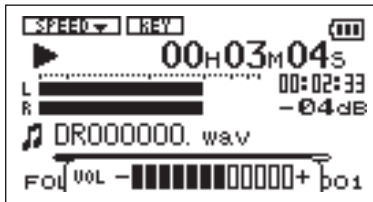

8-Recording

In addition to using the built-in microphone, you can record using an external microphone or record the output signal from a mixer or other audio source. You can select among MP3 (44.1/48 kHz, 32–320 kbps) and WAV (44.1/48 kHz, 16/24-bit) audio recording formats.

Selecting the file type and sampling frequency

Select the audio file type that you want to record before you start recording.

- 1 Press the **MENU** key to open the Menu Screen.
- 2 Select the **REC SETTING** item to open the Recording Settings Screen.

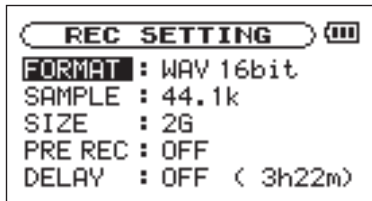

- 3 Use the **FORMAT** item to select the file type from the following options: **WAV** at 16-bit (factory setting) or 24-bit, or **MP3** at 32 kbps, 64 kbps, 96 kbps, 128 kbps, 192 kbps, 256 kbps, or 320 kbps.
- 4 Use the **SAMPLE** item to select a sampling frequency of 44.1 kHz (factory setting) or 48 kHz.

NOTE

For other special recording functions, see "Special functions during recording" on page 55.

8–Recording

TIP

- *WAV files do not use data compression and are truer to the character of the sound, but they use much memory. Since MP3 files use data compression, they do not use nearly as much memory. For example, ordinary audio CD tracks are 16-bit, 44.1 kHz WAV files. A 3.5–minute CD track uses about 35 MB of space when copied to a hard drive. The same track converted to a 128 kbps MP3 file uses only about 3.2 MB.*
- *If you are making a recording that you intend to use in the production of a CD, it is a good idea to record WAV files. If you have enough space, 24-bit recording gives you extra head room, allowing you to capture a greater dynamic range. When recording rehearsals, lectures and songwriting ideas, for example, and higher quality audio is not as important as smaller file size, MP3 may be a better choice. There are many excellent books (and resources on the Internet) about digital recording if you want to learn more about these formats.*

Selecting the input source

Follow these procedures to select the input source.

- 1 Press the MENU key and select INPUT SETTING item, then press the ►/|| key to open the Input Setting Screen.

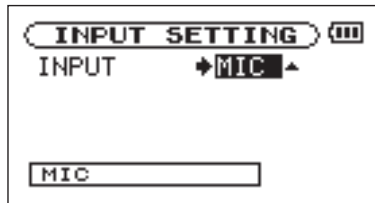

- 2 Use the INPUT item to select one of the following input sources.

8–Recording

MIC

Sets the input source as the built-in microphone when no microphone cable is connected to the **MIC IN** jack (stereo mini-jack). When a microphone cable is connected to the **MIC IN** jack, the input microphone signal becomes the input source.

If you select **MIC**, you should also set the input functions. (See “Setting the MIC input functions” below.)

LINE

Sets the source as the line level signal input to the right side panel **LINE IN** jack (stereo mini-jack).

CAUTION

Use headphones to monitor when you are recording with a microphone. If you use speakers to monitor, the sound output from the speakers may also be recorded, causing a poor recording and even feedback.

NOTE

The input source is the recording source when recording.

Setting the MIC input functions

After selecting **MIC** as the **INPUT** item, press the **◀◀** key to highlight **INPUT**, then turn the wheel right to open the **MIC Input Setting** screen.

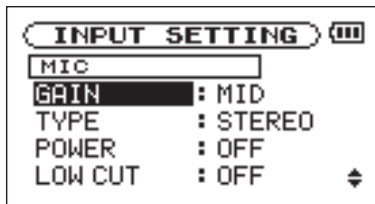

This screen has the following settings. Among these, **POWER**, is only effective to **MIC IN**. All the

8–Recording

other items affect both the built-in microphone and **MIC IN**.

GAIN

Set the input sensitivity as **HIGH**, **MID**, or **LOW**. The factory default setting is **MID**. Change it to **HIGH** if the input level is too low.

TYPE

Select **STEREO** or **MONO** according to the type of connected microphone. The factory setting is **STEREO**. If you select **MONO**, a mixed signal of the left and right input signals is provided to the left and right channels respectively.

POWER

When connecting an external microphone that requires plug-in power set this to **ON**. The factory default is **OFF**.

CAUTION

*Set this to **OFF** when using the built-in mic or connecting a dynamic microphone or microphone with a built-in battery. If set to **ON**, the*

plug-in power may damage such microphones.

LOW CUT

The factory default setting of the low cut filter is **OFF**, but you can also select **40Hz**, **80Hz** or **120Hz** as the cut-off frequency for a low cut filter.

TIP

Try using one of the low cut filter settings when recording outdoors or another place where the unwanted sound of wind is being recorded.

LEVEL CTRL

Use this to set the level control function.

Set it to **AUTO** to have the DR-07 automatically adjust the input gain according to the input level. Loud sounds and quiet sounds are both adjusted to the same level.

Set it to **LMT** to have the DR-07 automatically limit the input gain so that input level of loud sounds are reduced to prevent distortion.

The factory default setting is **OFF**.

8-Recording

NOTE

When recording live performances and in other situations where unexpected loud sounds might occur, set this function to LMT to prevent input clipping and allow recording without distortion.

Display of input functions on the Record Screen

Icons appear on the Record Screen to show the status of the TYPE, POWER, LOW CUT and LEVEL CTRL settings.

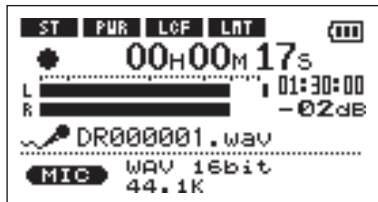

ST

When TYPE is set to STEREO, the **ST** icon appears as light letters on a dark background.

PWR

When POWER is ON, the **PWR** icon appears as light letters on a dark background.

LCF

When LOW CUT is set to 40Hz, 80Hz or 120Hz, the **LCF** icon appears as light letters on a dark background.

LMT

When LEVEL CTRL is set to AUTO or LMT, the **LMT** icon appears as light letters on a dark background.

Adjusting the input recording levels

You can adjust the recording level.

8-Recording

The following procedures explain how to use the Record Screen to set the levels.

- 1 Press the RECORD key to begin recording standby. The key flashes red and the Record Screen appears. The input signal is output from the Ω /LINE OUT jack.

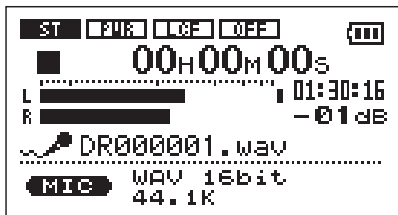

- 2 Use the REC LEVEL volume control on the right side of the unit to adjust the input level.

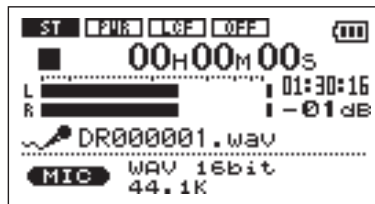
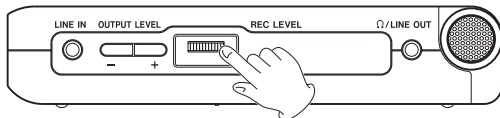

The L/R meter shows the input level. If the input is too high, a line remains at the right end of the level meter and the PEAK indicator to the left of the RECORD key lights.

Set the level as high as possible without causing the PEAK indicator to light when the loudest sounds occur.

- When you have selected MIC as the input source and are using the built-in microphone or MIC IN jack, if you find the level to be too low even when the REC LEVEL volume is at maximum, use the MIC Input Setting Screen to set the GAIN item to

8-Recording

MID or HIGH. (See “Setting the MIC input functions” on page 50.)

TIP

- *In addition to adjusting the REC LEVEL volume, try changing the distance and angle between the microphone and the sound source.*
- *To record the sound of a source most effectively and accurately, point the front of the DR-07's built-in mics toward the sound source with the LCD facing up.*
- *An easy way to set the input level is to raise it until the PEAK indicator lights while inputting as loud a noise as you expect to record. When the PEAK indicator lights, lower the input level until it no longer lights.*

NOTE

Press STOP/HOME to end recording standby.

Recording

Before starting the following operation procedures, input selection and level adjustment should be completed, and the Home Screen should be open.

- 1 Press RECORD to begin recording standby.

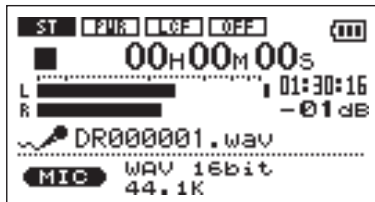

The screen shows the recording file name, the input source, the recording audio file type and sampling frequency. Please confirm that these are as desired before starting recording.

8-Recording

- 2 To start recording, press the RECORD key again.

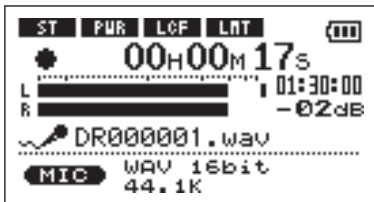

When recording starts, the RECORD key lights continuously, and the display shows the elapsed recording time and the remaining recording time.

- 3 Press the STOP/HOME key to end recording and create the audio file.
- To pause recording, press the RECORD key. Press the RECORD key again to restart recording in the same track. If you press the STOP/HOME key after pausing, a recorded

audio file up to the moment that you paused recording is created.

Special functions during recording

Track incrementing

Incrementing the track number manually

During recording, you can create a new file that has a number at the end of its file name that is one higher (incremented) and continue recording.

- 1 Press the ►► key during recording to create a new file with the number at the end of the file name incremented (increased) and continue recording in this file from its beginning (00:00:00).

You can increment even when paused.

8-Recording

CAUTION

- *You cannot increment if the total number of files would exceed 999.*
- *You cannot increment when the current file is only two seconds or shorter.*
- *When incrementing, if a file already exists with the incremented file name, the number will be increased again to create a new unique file name.*

Automatic track incrementing according to file size

When a file reaches a designated size during recording, you can set the unit to automatically create a new file with an incremented file name and continue recording.

- 1 Press the MENU key to open the menu list screen. Select REC SETTING and press the ►► key to open the Rec Setting screen.

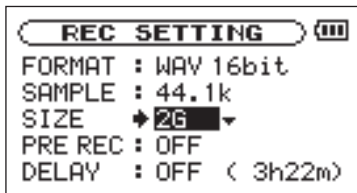

- 2 Use the SIZE item to select the file size for automatic incrementing.

Options: 64M, 128M, 256M, 512M, 1G, 2GB (default setting)

CAUTION

You cannot increment if the total number of files would exceed 999.

NOTE

The recording time differs for the same file size depending on the file format. Moreover, 23:59:59 appears if the recording time is 24 hours or more.

Pre-recording

When the unit is in recording standby, the unit can record the two seconds before the start of recording and include it in the recording.

Use the following procedures to set pre-recording.

1. Press the MENU key to open the menu list screen. Select REC SETTING and press the ►/|| key to open the REC SETTING screen.

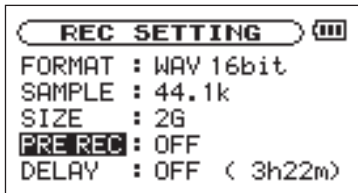

- 2 Use the PRE REC item to turn pre-recording ON or OFF.

Options: ON, OFF (default setting)

CAUTION

- *If the unit has been in recording standby for less than two seconds, only the amount of time that the unit has been in standby will be included*
- *Pre-recording is not possible if the remaining space on the SD card is three seconds or less.*

Recording delay

This function allows the start of recording from the time of pressing the RECORD key to be delayed 10 ms (this time is fixed).

This is convenient if you want to avoid recording the sound of the RECORD key being pushed.

- 1 Press the MENU key to open the menu list screen. Select REC SETTING and press the ►/|| key to open the REC SETTING screen.

8-Recording

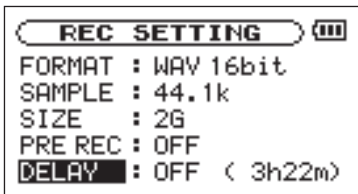

- 2 Use the **DELAY** item to turn recording delay **ON** or **OFF**.

Options: **ON**, **OFF**(default setting)

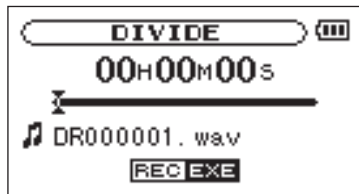

- 2 Use the wheel to locate the point where you want to divide the file.

NOTE

- You can press the **PLAY** key and select the point where you want to divide the file during playback.
- You can also press the **REW** key to move the location towards the beginning of the recording or the **FWD** key to move the location towards the end of the recording. You cannot divide a track at its beginning or end.

File divide function

You can divide one file into two at the time of your choice. For example, you can divide a large file or multiple songs into several consecutive files or use this function to erase unnecessary recordings.

- 1 Press the **MENU** key to open the menu list screen. Select **DIVIDE** and press the **▶/||** key to open the **DIVIDE** screen

8-Recording

Press the RECORD key to open a confirmation screen and press the ►/|| key to confirm.



The file is divided and the Home Screen reopens.

NOTE

- When a file is divided, the two files that are created are given the same file name with the suffixes "_a" and "_b" at the ends of their names. If you further divide a file that already has an "_a" at the end of its file name, the split files will have the suffixes "_a_a" and "_a_b".

- This function cannot be used if the remaining space on the SD card is low.

CAUTION

- You cannot divide a file if the resulting file names would be 200 or more characters long.
- You cannot divide a file if a resulting file name would be the same as the name of an already existing file.

9-Playback Area and Playlist

On the Home Screen, you can use the ◀◀ and ▶▶ keys to select the playback track. The files that you can select are determined by the playback area setting.

Limiting the playback area makes track selection easier when you have numerous recorded and copied tracks on the SD card.

On the Play Mode Screen, you can select all files, the current folder or the playlist as the playback area. You can also use the Browse Screen to set a folder as the playback area.

TIP

On the Browse Screen, regardless of the playback area setting, you can select any file on the card that you want.

Setting the playback area

Use the following procedures to select the playback area on the Play Mode Screen.

- 1 Press the MENU key to open the Menu Screen and select PLAY MODE. Press the ▶/|| key to open the Play Mode Screen.

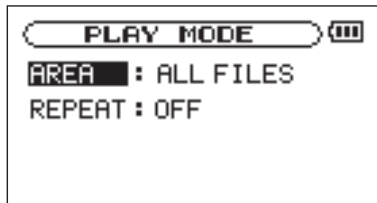

- 2 Select the AREA item and press ▶/||.
- 3 Set the playback area to one of the following options.

9-Playback Area and Playlist

NOTE

The current playback area setting appears in the lower left of the Home Screen.

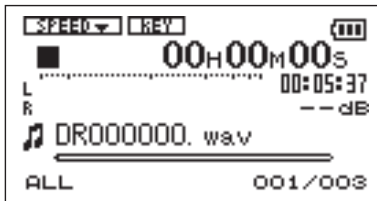

ALL

Set the playback area as all files in the Music Folder on the SD card.

FOLDER

Set the playback area as all the files in the currently selected folder.

PLAYLIST

Set the playback area as the tracks in the playlist.
(See “Playlist” on page 63.)

If there is no playlist defined, a “No PLAYLIST” pop-up appears.

Selecting a folder for the playback area

Regardless of the current playback area, if you select a folder on the Browse Screen, the playback area changes to the selected folder.

1. Press the MENU key to open the Menu Screen, and select the BROWSE item. Press the ►/|| key to open the Browse Screen.

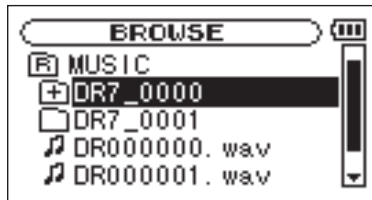

9-Playback Area and Playlist

- 2 Select the desired folder.

For an explanation of how to use the Browse Screen, see “Screen navigation” on page 67.

- 3 Press the ►/|| key to open the following pop-up window.

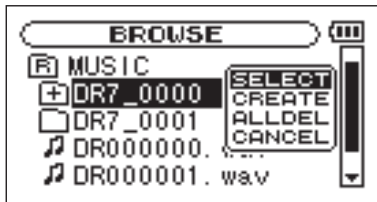

- 4 Select the SELECT item and press ►/||.

The display returns to the Home Screen, and the first file in the folder is selected. This folder becomes the playback area regardless of the previous playback area setting.

Selecting a file to set the playback area

When the playback area is set to FOLDER, if you select a file on the Browse Screen, the folder that contains the selected file becomes the playback area.

- 1 Press the MENU key to open the Menu Screen and select the BROWSE item. Press the ►/|| key to open the Browse Screen.

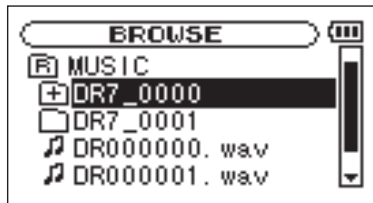

9-Playback Area and Playlist

- 2 Select the file you want.

For an explanation of how to use the Browse Screen, see “Screen navigation” on page 67.

- 3 Press the ►/|| key to open the following pop-up window.



- 4 Select the PLAY item and press ►/||.

The display returns to the Home Screen, and the selected track starts playing. In addition, the folder that contains this track becomes the playback area regardless of the playback area folder set previously.

Playlist

You can make a list of tracks for playback (playlist). On the Play Mode Screen if you select PLAYLIST for the AREA item, you can set playback to just the tracks in your playlist.

Adding tracks to the playlist

- 1 Press the MENU key to open the Menu Screen. Select the BROWSE item and press the ►/|| key to open the Browse Screen.

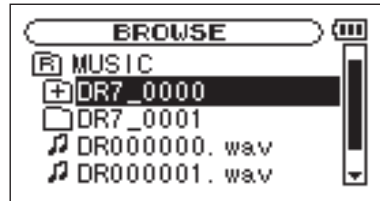

9-Playback Area and Playlist

- 2 Select a track that you want to add to the playlist and press the ►/|| key.

A pop-up window appears.



- 3 Select ADD LIST and press the ►/|| key.

The track is added to the playlist and the popup window closes.

- 4 Repeat steps 2 and 3 as necessary to add more tracks to the playlist. The tracks are numbered in the order that they are added.

NOTE

For an explanation of how to use the Browse

Screen and how to select tracks, see "Screen navigation" on page 67.

Editing the playlist

You can view and edit the playlist you have made on the Playlist Screen.

You can also use this screen to play tracks and to edit the playlist.

- 1 Press the MENU key to open the Menu Screen. Select PLAYLIST and press the ►/|| key to open the Playlist Screen.



9-Playback Area and Playlist

- 2 Select the file that you want to edit and press the ►/|| key to open a pop-up window.



Use the wheel to select the item you want and press the ►/|| key. Their functions are as shown below.

PLAY

Play the file and return to the Home Screen.

ALL CLR

A confirmation message appears to confirm that you want to remove all the files from the playlist.

Press the ►/|| key to remove all the files or the STOP/HOME key to cancel this operation.

For this operation, it does not matter which track you select in step 2. All the files are removed from the playlist, but they are not erased from the SD card.

DELETE

Remove the selected track from the playlist.

The file is removed from the playlist, but it is not erased from the SD card.

MOVE

Select this to change the order of tracks in the playlist.

In addition to the file name, the track number also appears highlighted in inverse.

In step 2, use the wheel to move the track to a different position in the playlist.

9-Playback Area and Playlist



In the above example, the 4th track has been moved to the 3rd track position.

- 3 Press the ►/|| key to complete the move and return to the ordinary Playlist Screen.

10–Browse Screen

On the Browse Screen, you can view the contents of the Music Folder, which contains the audio files on the SD card that you can use with the DR-07. On this screen, you can also play and erase selected audio files, create folders, add tracks to the playlist and so on. (See “Playlist” on page 63.)

To open the Browse Screen, press the **MENU** key to open the Menu Screen. Select **BROWSE** and press the **▶/||** key.

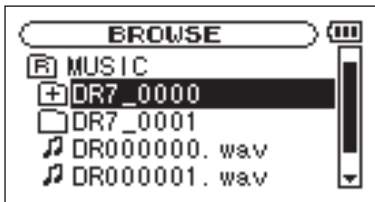

The contents of the folder that contains the file that was selected on the Home Screen before the Browse Screen was opened appears on the display.

TIP

If you connect the DR-07 with a computer by USB, or mount the SD card on a computer using a card reader or other input, you can change the folder structure within the Music Folder and erase files from the computer as you would the contents of a hard drive. Furthermore, you can change file names from the computer.

Screen navigation

On the Browse Screen, folders and music files appear in a hierarchical structure much like they would appear on a computer. On the DR-07, folders can only be used to two levels.

- Use the wheel to select files and folders.
- When a folder is selected, press the **▶▶|** key to show the contents of that folder.
- When a file or folder is selected, press the **◀◀** key to exit the currently open folder and go to a higher level in the folder structure.

10–Browse Screen

Icons on the BROWSE screen

The meanings of icons that appear on the Browse Screen are as follows.

Root Music Folder

The Music Folder is the highest (root) level folder in the hierarchy shown on the Browse Screen.

Audio file

This icon appears before the names of music files.

Plus folder

This icon shows folders that contain subfolders.

Plain folder

This icon shows folders that do not contain subfolders.

Open folder

The contents of the folder marked with this icon currently appear on this screen.

File operations

Select the desired audio file on the Browse Screen and press the  key to open the pop-up window that is shown below.



Use the wheel to select the item you want from the following list and press  to execute it.

PLAY

Plays the file. The display returns to the Home Screen. If the playback area is set to `FOLDER`, the playback area becomes the folder that contains the playing file.

10–Browse Screen

INFO

Displays the information of the selected file.

ADD LIST

Adds the selected file to the playlist. (See “Playlist” on page 63.)

DELETE

A message appears to confirm that you want to delete the file. Press the ►/|| key to erase the file and the STOP/HOME key to cancel the deletion operation.

CANCEL

No operation is conducted and the selected file is left as is.

Folder operations

Select the desired folder on the Browse Screen and press the ►/|| key to open the pop-up window that is shown below.

NOTE

When the BROWSE screen is open and an audio file is selected, pressing the ◀◀ key causes the folder that contains the file to be selected (go up a level).

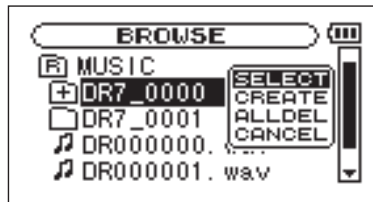

Use the wheel to select the item you want from the following list and press ►/|| to execute it.

SELECT

Returns to the Home Screen and selects the first file in the folder. This folder becomes the new playback area regardless of the previous playback

10–Browse Screen

area setting. When recording, files are created in this folder.

CREATE

A pop-up appears to confirm that you want to create a new folder. Press the ►/|| key to create a new folder, or press the **STOP/HOME** key to cancel the operation.

However, if you try to create a new folder inside a second level subfolder the message, “`L a y e r
t o o d e e p`” appears and the folder is not made.

ALLDEL

All files in the selected folder are deleted but sub-folders are not deleted. Also, read-only files are not deleted. Furthermore, files which are not recognized by the DR-07 are left as they are.

CANCEL

No operation is conducted and the selected folder is left as is.

11–Special Playback Control Functions

Not only can you use the DR-07 to change the tempo of track playback, you can even do this without changing the pitch. You can also change the playback pitch of a track without changing the tempo.

You can use these playback control functions effectively to practice and learn parts.

Setting the playback control functions

Use the Playback Control Screen to set the playback control functions. When the Home Screen is displayed, press and hold the **PB CONT** key to open the Playback Control Screen.

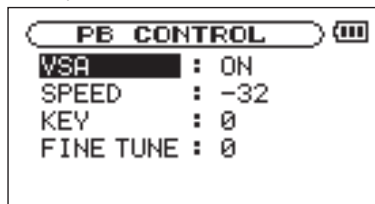

After you finish making settings on this screen, press the **STOP/HOME** key (or press and hold the **PB CONT** key) to return to the Home Screen.

In the upper part of the Home Screen, the icons for the playback control functions that are currently active appear highlighted in inverse.

11–Special Playback Control Functions

Changing the speed

Use the **SPEED** item to set the speed of playback. However, setting the speed does not automatically make the speed control function active. After setting it, briefly press the **PB CONT** key to turn the speed control ON, making it active. When ON, the **SPEED** icon appears as light letters on a dark background in the upper part of the Home Screen. You can turn the speed control ON and OFF by briefly pressing the **PB CONT** key, so you can easily switch between the set speed and the normal speed.

Since the speed adjustment range is -50% to $+16\%$ (in 1% increments), the slowest speed setting is half the original speed.

NOTE

*Briefly pressing the **PB CONT** key to turn the speed setting function ON and OFF is unique to this function. For all other playback control functions, changing the setting on the Playback*

Control Screen from anything other than the factory default results in the function being turned ON all the time.

Change speed without changing pitch

Turn the Variable Speed Audition (VSA) function ON to keep the pitch the same when changing the tempo. Use the **VSA** item to turn the VSA function ON and OFF (the factory setting is ON).

11–Special Playback Control Functions

Changing the pitch without changing the speed

Use the **KEY** item to change the pitch in semitones without changing the tempo.

Use the **KEY** item to adjust the pitch up or down by 1–6 semitones (#6–b6) (the factory setting is 0).

If you change the key to any value besides 0, the key change function turns ON and the **KEY** icon appears on the Home Screen as light letters on a dark background.

Use the **FINE TUNE** item to adjust the pitch up or down in cents (100 cents = 1 semitone).

NOTE

*Even if you use the **FINE TUNE** item to adjust the key, as long as the **KEY** item setting is 0, the **KEY** icon will not appear as light letters on a dark background on the Home Screen.*

12–Loop, Repeat and Single Playback



In ordinary playback mode, once playback starts, it will stop when the end of the last track in the current playback area is reached (or you press the **STOP/HOME** key). By following the instructions in this chapter, however, you can also make the DR-07 loop a section of a track that you choose, repeat the entire sequence of tracks in the current playback area, play a single track repeatedly or play a single track once and stop.

Loop playback

With this function, you can continuously repeat (loop) the playback of a selection that you make.

- 1 Press the I/O LOOP key during playback to set the point when you want to start loop playback. The current position is set as the IN point.**
- 2 Press the I/O LOOP key at the point when you want loop playback to stop. The current position is set as the OUT point, and loop**

playback begins between the IN and OUT points.

The current positions of the IN and OUT points are shown by the  and  icons that appear below the playback position display bar in the lower part of the Home Screen. During loop playback the  indicator also appears.

To stop loop playback, press the **I/O LOOP** key. The loop playback area setting is also cleared at the same time.

NOTE

Accurate assignment of IN and OUT points is not always possible for variable bit rate (VBR) MP3 files.

12–Loop, Repeat and Single Playback

Repeat and single track playback modes

You can set the DR-07 to repeatedly play the current track or all tracks in the playback area, as well as play just a single track once.

- 1 Press the **MENU** key to open the Menu Screen. Select **PLAY MODE** and press the **▶/||** key. The Play Mode screen appears.

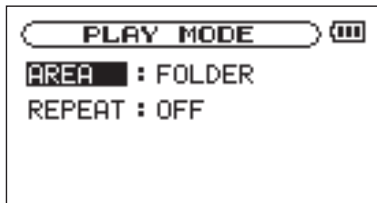

- 2 Select the **REPEAT** item to set the playback mode to one of the following options.

- **OFF:**

All tracks in the playback area are played in sequence one time. (This setting is the ordinary playback mode.)

- **SINGLE:**

The selected track is played once without repeating. The  icon appears on the Home Screen.

- **1 REPEAT:**

The current track is played repeatedly. The  icon appears on the Home Screen.

- **ALL REPEAT:**

All tracks in the selected playback area are played back repeatedly.

The  **ALL** icon appears on the Home Screen.

NOTE

*If you start loop playback, the **REPEAT** item automatically switches to **OFF** if it is in a different mode.*

13–System Settings and Formatting

From the Setup Screen, you can change various settings to optimize the device for your use environment and other requirements. You can also initialize and format the SD card.

To open the Setup Screen, press the **MENU** key. Select **SETUP** from the Menu Screen and press the **▶/||** key.

The following settings can be made for the items on the Setup Screen.

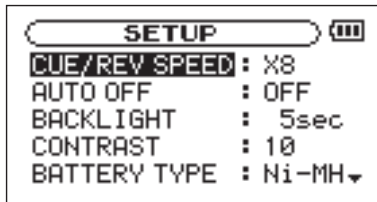

Making System Settings

Setting the search speed

Use the **CUE/REV SPEED** item to set the speed of forward and backward searching when pressing and holding the **▶▶** and **◀◀** keys.

Options: x2, x4, x8 (factory setting), x10

Turning the unit power OFF automatically

Use the **AUTO OFF** item to set the time before the unit power automatically turns OFF after the last activity or use when powered by the internal batteries.

Options: OFF (factory setting—the unit does not automatically turn OFF), 3 min, 5 min, 10 min, 30 min

Backlight Auto OFF setting

Use **BACKLIGHT** to set the time until the backlight automatically turns OFF after the last operation when powered by the internal batteries.

13–System Settings and Formatting

Options: OFF (backlight always on), 5 sec (factory setting), 10 sec, 15 sec, 30 sec

Adjust the display contrast

Use CONTRAST to adjust the display contrast.

Options: 1–20 (factory setting: 10)

Select the type of batteries

Use BATTERY TYPE to select the type of batteries. This setting is used to distinguish the remaining minimum power required for the normal operation or to display the batteries' remaining power.

Options: ALKAL (alkaline battery (factory setting)), Ni-MH (nickel-metal hydride)

Restoring the factory settings

Use the INITIALIZE item to restore the various settings of this unit to their factory settings.

1 Select INITIALIZE and press the ►/|| key

to highlight “Exec.”

2 Press the ►/|| key again to open a confirmation pop-up window.

3 Press the ►/|| key to initialize the unit. Press STOP/HOME to cancel initialization.

Formatting the SD card

Using QUICK FORMAT or FULL FORMAT erases all music files on the card and automatically creates new “MUSIC” and “UTILITY” folders as well as the “dr-1.sys” file that is necessary to use the SD card with the DR-07.

CAUTION

When the unit is shipped new from the factory, its SD card also has a “MANUAL” folder that contains a PDF copy of this Owner’s Manual file. These are erased and not restored when the card is formatted.

13–System Settings and Formatting

Using QUICK FORMAT

Use the **QUICK FORMAT** item to quickly format the SD card.

- 1 Select the **QUICK FORMAT** item and press the **▶/||** key to highlight “Exec.”
- 2 Press **▶/||** to open a pop-up confirmation window.
- 3 Press the **▶/||** key to execute the quick formatting, or press the **STOP/HOME** key to cancel formatting.

Using FULL FORMAT

Use the **FULL FORMAT** item to completely format the SD card.

Full formatting checks the memory for errors while formatting, so it takes more time than quick formatting and you might have to wait a while.

NOTE

Full formatting of a 2GB SD card takes about 20 minutes or more depending on the type of SD card.

- 1 Select the **FULL FORMAT** item and press the **▶/||** key to highlight “Exec.”
- 2 Press **▶/||** to open a pop-up confirmation window.
- 3 Press the **▶/||** key to execute the full formatting, or press the **STOP/HOME** key to cancel formatting.

CAUTION

- *When using **FULL FORMAT**, use the AC adapter (sold separately) or confirm that the batteries’ power remains enough. If the power fails during formatting, the formatting may not occur correctly.*
- *Depending on the size of the SD card, **FULL FORMAT** could take an hour or more. Please be patient and do not disconnect the power during formatting.*

14–Viewing File Information

Use the Information Screen to view various types of information about your DR-07.

To open the Information Screen, first press the **MENU** key to open the Menu Screen. Select “INFORMATION” and press the **▶/||** key.

Use the **wheel** to switch between the following three information pages.

File information page (FILE)

Shows information about the currently playing file.

Card information page (CARD)

Shows the use status of the currently inserted SD card

System information page (SYSTEM)

Shows the unit’s system setting information and firmware version

File information page

The **FILE** page shows information about the currently selected file.

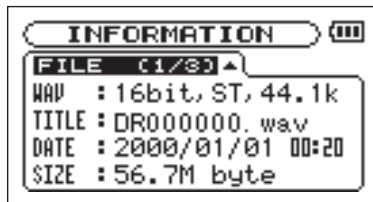

WAV or MP3

Shows the audio file type.

For WAV files, bit length, stereo/mono, and sampling frequency (Hz) also appear.

For MP3 files, the bit rate (kbps), CBR (constant bit rate) or VBR (variable bit rate) type, and sampling frequency (Hz) also appear.

14-Viewing File Information

TITLE

Shows the file name. If an MP3 file has ID3 tag title information, that information appears.

DATE

The date of the file appears..

SIZE

The size of the file appears.

Card information page

The **CARD** page shows the status of the currently inserted SD card.

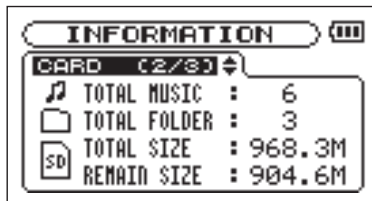

TOTAL MUSIC

Shows the number of playable files contained by the Music Folder.

TOTAL FOLDER

Shows the total number of folders in the Music Folder.

TOTAL SIZE

Shows the total SD card memory capacity.

REMAIN SIZE

Shows the amount of unused memory on the SD card.

14-Viewing File Information

System information page

The `SYSTEM` page shows information about the DR-07's system settings and firmware version.



CUE/REV SPD

Shows the speed of forward and backward searching.

AUTO OFF

Shows the automatic power OFF setting.

BACKLIGHT

Shows the automatic backlight OFF setting.

System Ver.

Shows the system firmware version.

15-LCD Menu List

Menu Item	Page	Setting/ Operation Item	Descriptions
INFORMATION	FILE (1/3)		File information display
	CARD (2/3)		SD card information display
	SYSTEM (3/3)		System information display
BROWSE			File operation in SD card
PLAYLIST			Edit the playlist
PLAY MODE		AREA	Set the repeat area
		REPEAT	Set repeat mode

15-LCD Menu List

Menu Item	Page	Setting/ Operation Item	Descriptions
INPUT SETTING		INPUT	Set the input source (MIC/LINE)
	MIC	GAIN	Set the GAIN of the MIC input
		TYPE	Set the stereo/mono of the MIC input
		POWER	Set the On/Off of the phantom power to the MIC input
		LOW CUT	Set the Low Cut Filter (OFF/40 Hz/80 Hz/120 Hz)
		LEVEL CTRL	Set the control function of the MIC input level (OFF/AUTO/Limiter)
REC SETTING		FORMAT	Set the format of music files
		SAMPLE	Set the sampling frequency
		SIZE	Set the maximum file size
		PRE REC	Set the On/Off of the pre-recording
		DELAY	Set the On/Off of the recording delay
DIVIDE			Divide files

15-LCD Menu List

Menu Item	Page	Setting/ Operation Item	Descriptions
SETUP		CUE/REV SPEED	Set the fast forward/rewind speed (x2/x4/x8/x10)
		AUTO OFF	Set the auto shut down time when operated by batteries (Off/3 min/5 min/10 min/30 min)
		BACKLIGHT	Set the auto backlight turn off time (Off/5 sec/10 sec/15 sec/30 sec)
		CONTRAST	Set the LCD contrast
		BATTERY TYPE	Set the battery type
		INITIALIZE	Execute the initialization
		QUICK FORMAT	Execute the quick format
		FULL FORMAT	Execute the full format
DATE/TIME			Set the date and time

16–Messages

The following is a list of the popup messages that might appear on the DR-07 under certain conditions.

Refer to this list if one of these popup messages appears and you want to check the meaning or determine a proper response.

Message	Meaning and response
File Name ERR	The length of the file name is longer than 200 characters when the Divide is used.
Dup File Name	The same file name already exists when a new file is created when the Divide is used.
File not found	The audio file cannot be found or is corrupted. Check the file (using a computer).
Non- Supported	The audio file is not a supported format. Check the file format (using a computer).
Battery Empty	The batteries are almost out of power. Replace the batteries or use an AC adapter (sold separately).
I/O Too Short	When using the I/O LOOP key, the IN and OUT points are too close together to start loop playback. Set the interval to at least one second. Reset the IN and OUT points and try again.

16–Messages

Message	Meaning and response
File Not Found PLAYLIST	The file in the Playlist cannot be found. Please confirm that the file is still in the Music Folder.
No PLAYLIST	No files are in the Playlist. This appears when the PLAY MODE is set to PLAYLIST, but no files have been added to the Playlist. Add a file to the Playlist. See “Adding tracks to the playlist” on page 63.
PLAYLIST FULL	You cannot add more than 99 tracks to the Playlist. Erase an unneeded file from the Playlist and then add the new file. See “Editing the playlist” on page 64.
MBR Error Init CARD	There is a problem with the Master Boot Record. The card is not formatted properly or the formatting is broken. When “Are you Sure?” appears, press the ►/ key to format the entire card in FAT format. CAUTION Execution of FAT formatting erases all data currently on the card.

16–Messages

Message	Meaning and response
Format Error Format CARD	<p>The FAT formatting of the card is abnormal or broken. This message also appears if you FAT formatted the card using a computer connected by USB (or by card reader). This message also appears when a new card is inserted in the unit. Always use the DR-07 to conduct FAT formatting of cards to be used with it.</p> <p>When “Are you Sure?” appears, press ►/ to FAT format the entire card.</p> <p>CAUTION Execution of FAT formatting erases all data currently on the card.</p>
File Not Found Make Sys File	<p>The system file is missing. This unit requires a system file for operation. When “Are you Sure?” appears, press ►/ to automatically create a system file.</p>
Invalid SysFile Make Sys File	<p>The system file is invalid. The system file required to operate this unit has become abnormal or broken. When “Are you Sure?” appears, press the ►/ key to automatically create a valid system file.</p>
Invalid Card Change Card	<p>This appears when there is some type of error with the card.</p>

16–Messages

Message	Meaning and response
Protected Card Change Card	This appears when the card in the unit during startup is a protected card without the necessary Music Folder and other folders and files.
Write Timeout	Writing to the card timed out. Backup files on the card to your computer, and format the card using the DR-07.
Card Full	Erase unnecessary files or move them to your computer to make open space.
Layer too Deep	A folder cannot be created below this level.
Can't Divide	The position set for division is not suitable (song beginning or end).
Max File Size	The file is larger than the designated size or the recording time exceeds 24 hours.
File Full	The total number of folders and files is already 999. Erase unnecessary files or move them to your computer.
Card Error	There was some sort of error with the card. Turn off the power and replace the card with a working card.

16–Messages

Message	Meaning and response
Not Continued	If any of these errors occur, turn the DR-07 power OFF and restart the unit. If the error message continues to appear, contact a TEAC Repair Center.
File Error	
Can't Save Data	
Player Error	
Device Error	
Writing Failed	
Sys Rom Err	
System Err 50	
System Error 1	

16–Messages

Message	Meaning and response
System Error 2	If any of these errors occur, turn the DR-07 power OFF and restart the unit. If the error message continues to appear, contact a TEAC Repair Center.
System Error 3	
System Error 4	
System Error 5	
System Error 6	
System Error 7	
System Error 8	
System Error 9	

17-Specifications

Audio Input and Output

MIC IN input

Jack	3.5-mm stereo phone (with plug-in power)
Input impedance	30 k Ω
Nominal input level	-64 dBV (GAIN set to HIGH) -48 dBV (GAIN set to MID) -32 dBV (GAIN set to LOW)
Maximum input level	-48 dBV (GAIN set to HIGH) -32 dBV (GAIN set to MID) -16 dBV (GAIN set to LOW)

LINE IN input

Jack	3.5-mm phone (stereo)
Input impedance	23 k Ω
Nominal input level	-10 dBV
Maximum input level	+6 dBV

Ω /LINE OUT output

Jack	3.5-mm phone (stereo)
Nominal line output	-14 dBV
Maximum line output	+2 dBV
Maximum headphones output	15 mW + 15 mW (with 32 Ω impedance headphones)

17–Specifications

Audio performance

Frequency response (LINE IN > Ω/LINE OUT)

Distortion (LINE IN > Ω/LINE OUT)

S/N ratio (LINE IN > Ω/LINE OUT)

20 Hz–20 kHz, +1/-3 dB

0.015% or less (at 1 kHz, +6 dBV input)

87 dB or more

Other specifications

Audio file compatibility

MP3 files

32–320 kbps

44.1/48 kHz sampling frequency

VBR (playback only)

ID3 tag support up to Ver 2.4

WAV files

44.1/48 kHz sampling frequency

16/24-bit rate

Recording medium

SD card (64 MB–2 GB) or SD HC card (4–32 GB)

File system

FAT16/32

Physical

Battery life (continuous operation)

About 7.5 hours when recording

About 8.5 hours when playing

(using alkaline batteries, no back light, MP3 128 kbps, varies with operating conditions)

Operating temperature

5 to 35°C

Power consumption

0.7 W (during MP3 playback)

17-Specifications

Dimensions (not including protrusions)	55 (W) x 137 (H) x 27 (D) (mm) 2.2 (W) x 5.4 (H) x 1.1 (D) (inches)
Weight	130 g (without batteries)

Computer requirements

Windows

Pentium 300 MHz or faster
128 MB or more memory
USB port (USB 2.0 recommended)

Macintosh

Power PC, iMac, G3, G4 266 MHz or faster
64 MB or more memory
USB port (USB 2.0 recommended)

Recommended USB host controller

Intel chipset

Supported OS

Windows 2000 SP4 or later, Windows XP and Windows Vista
Mac OS X 10.2 or later

Accessories available for purchase

AC adapter (PS-P520)

17-Specifications

Dimensions

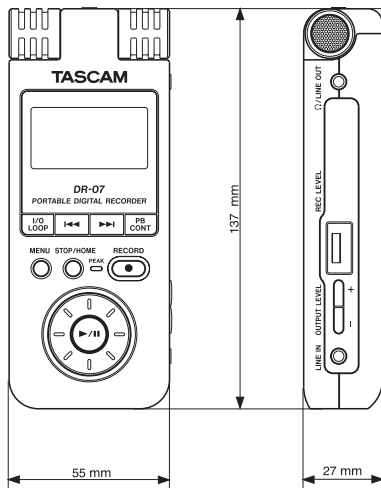

- Specifications and external appearance may be changed without notification to improve the product.
- Illustrations and other depictions in the owner's manual may differ in part from the actual product as a result of product improvements.

TASCAM
TEAC PROFESSIONAL
DR-07

TEAC CORPORATION

Phone: +81-42-356-9143
1-47 Ochiai, Tama-shi, Tokyo 206-8530 Japan

www.tascam.jp

TEAC AMERICA, INC.

Phone: +1-323-726-0303
7733 Telegraph Road, Montebello, California 90640, U.S.A.

www.tascam.com

TEAC CANADA LTD.

Phone: +1905-890-8008 Facsimile: +1905-890-9888
5939 Wallace Street, Mississauga, Ontario L4Z 1Z8, Canada

www.tascam.com

TEAC MEXICO, S.A. de C.V.

Phone: +52-55-5010-6000
Río Churubusco 364, Colonia Del Carmen, Delegación Coyoacán, CP 04100, México DF, México

www.teacmexico.net

TEAC UK LIMITED

Phone: +44-8451-302511
Suites 19 & 20, Building 6, Croxley Green Business Park, Hatters Lane, Watford, Hertfordshire. WD18 8TE, U.K.

www.tascam.co.uk

TEAC EUROPE GmbH

Phone: +49-611-71580
Bahnstrasse 12, 65205 Wiesbaden-Erbenheim, Germany

www.tascam.de
